

Article number: 20908STM422AA

Description: E+G Threaded plug DIN 908-ST-M42x2-AA

Measures

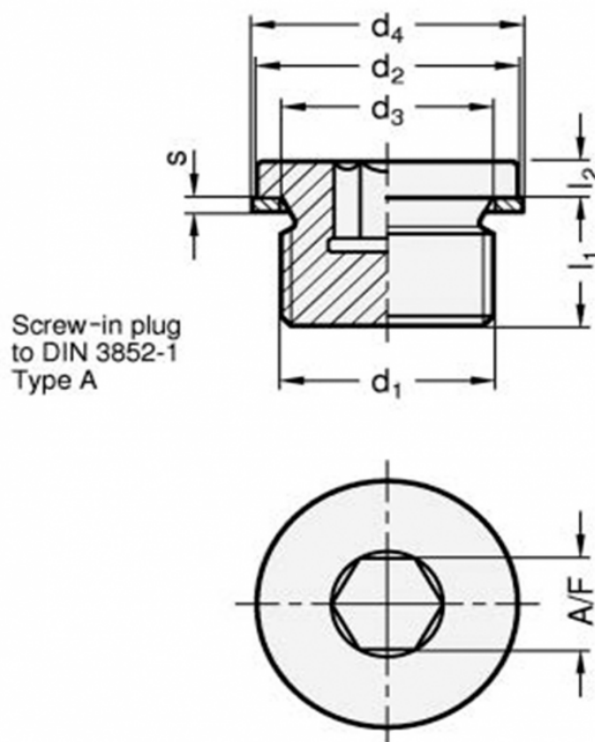

A/F	= 22
d1	= M42x2
d2h14	= 49
d3	= 42.3
d4	= 49
l1	= 16
l2	= 5
s	= 2

Weight in (g) = 190